

ALITA_linear air pumps



- 1.1_Models of the standard pump
- 1.2_Models pressure & vacuum
- 1.3_OEM series of the air pump



INECO

**Air and Vacuum
Components**

www.in-eco.eu

1

ALITA_linear air pumps

Alita linear air pumps are an effective source of compressed air. They are designed to have a low noise level and low energy consumption. Air circulation is created by the vibrating movement of flexible membranes (1), placed in covers (2) with non-return valves (3). The permanent magnet (4), on which the membranes are anchored, is moved by an alternating magnetic field with a generated electromagnetic coil pair (5). The entire process functions without mechanical friction and a low noise level.

Characteristics:

- > smooth air flow
- > low noise level and vibrations
- > high efficiency
- > low energy consumption
- > long service life
- > oil-free model
- > compact and light design
- > simple maintenance
- > heat protection
- > indoor and outdoor use
- > reliable interrupted and continuous operation
- > safety design
- > automatic membrane defect indication

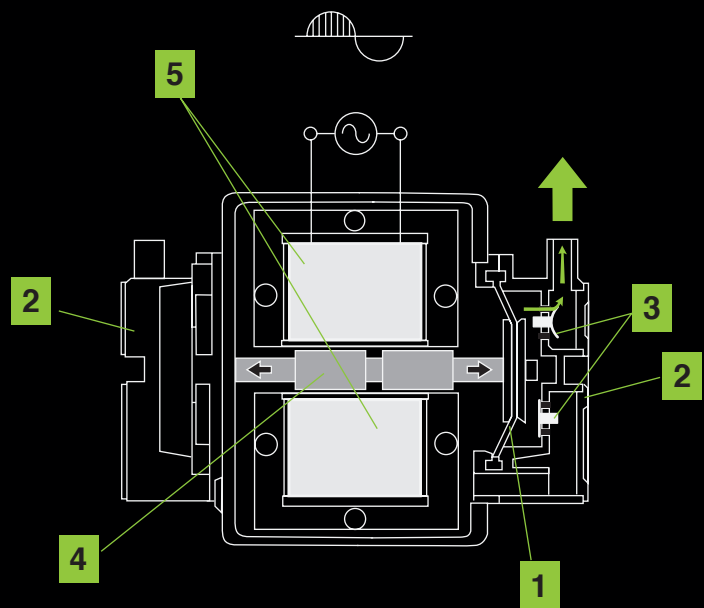

1

ALITA_linear air pumps

1.1

Models of the standard pump

1

ALITA_linear air pumps

1.1

Models of the standard pump

ALITA_linear air pumps

Models of the standard pump **AL-40, AL-60, AL-80**

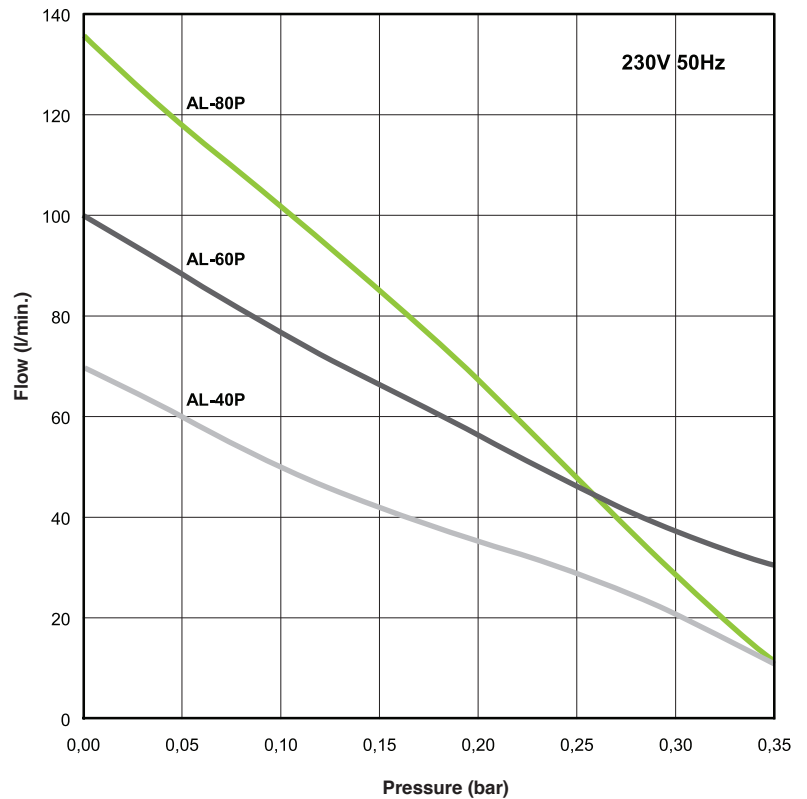

Model	AL-40	AL-60	AL-80
Max. rated input power	48 W	72 W	86 W
Sound level	36 dB	38 dB	39 dB
Weight	5.6 kg	6.5 kg	6.5 kg
Output ø	18 mm		
Max. rated pressure	220 mbar		
Rated input power (Max. rated pressure)	40 W	50 W	52 W
Voltage, freq	230V 50Hz		
Cover IP	IP54		
Dimension L x W x H	205 mm x 173 mm x 202 mm		

The single phase machines are designed with a +/- 10 % tolerance.. Information presented is based on test results from nominal units. Specifications are subject to change without notice.

ALITA_linear air pumps

Models of the standard pump **AL-100, AL-120, AL-150, AL-200**

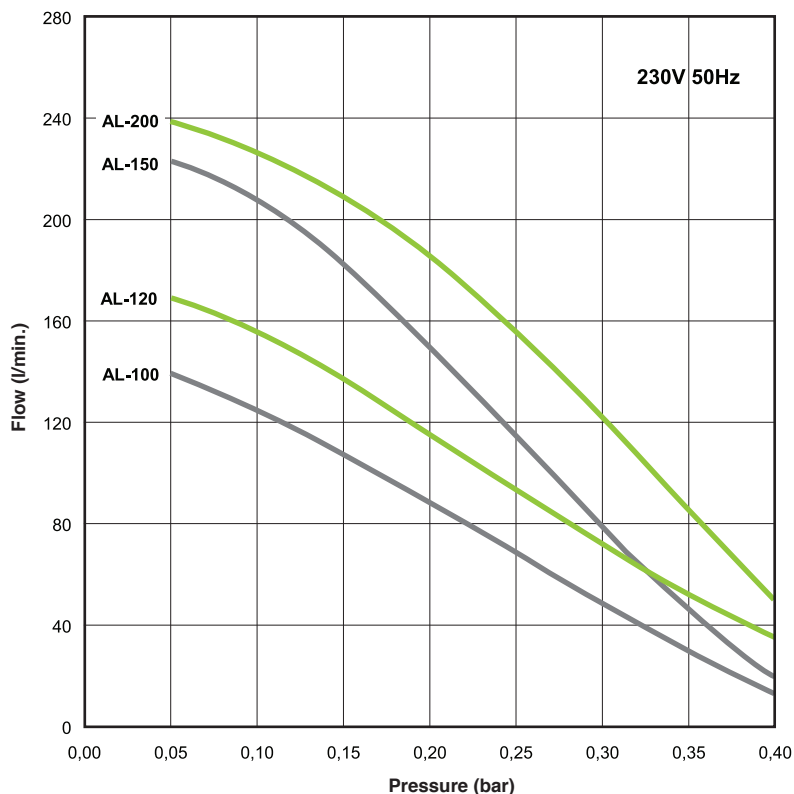

Model	AL-100	AL-120	AL-150	AL-200
Max. rated input power	120 W	124 W	160 W	261 W
Sound level	41 dB	42 dB	44 dB	45 dB
Weight	8.3 kg	8.3 kg	10.1 kg	10.1 kg
Output \varnothing	18 mm		26 mm	
Max. rated pressure	260 mbar			
Rated input power (Max. rated pressure)	78 W	97 W	110 W	125 W
Voltage, freq	230V 50Hz			
IP coverage	IP54			
Dimension L x W x H	248 mm x 205 mm x 245 mm			

The single phase machines are designed with a +/- 10 % tolerance.. Information presented is based on test results from nominal units. Specifications are subject to change without notice.

ALITA_linear air pumps

Models of the standard pump **AL-250, AL-300, AL-400**

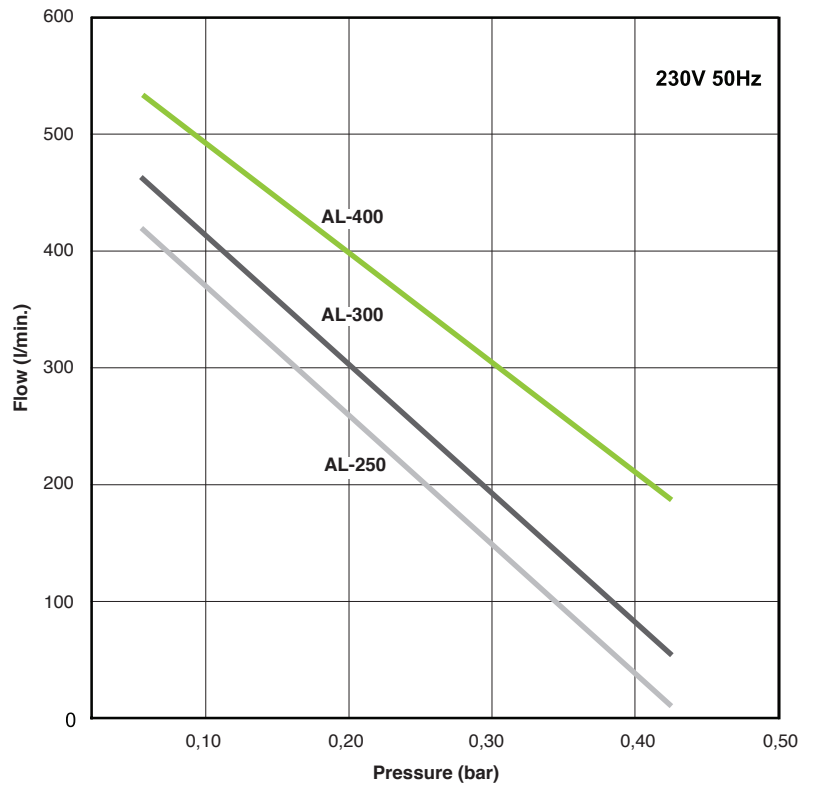

Model	AL-250	AL-300	AL-400
Max. rated input power	240 W	290 W	440 W
Sound level	46 dB	47 dB	49 dB
Weight	18,8 kg	22,1 kg	22,2 kg
Output \varnothing	30 mm		
Max. rated pressure	260 mbar		
Voltage, freq	230V 50Hz		
IP coverage	IP54		
Dimension L x W x H	420 mm x 248 mm x 262 mm		

The single phase machines are designed with a +/- 10 % tolerance.. Information presented is based on test results from nominal units. Specifications are subject to change without notice.

1

ALITA_linear air pumps

1.2

Models pressure & vacuum

ALITA_linear air pumps

Models pressure & vacuum

Models pressure
AL-6A, AL-15A



Models pressure & vacuum
AL-6SA, AL-15SA, AL-30MSA

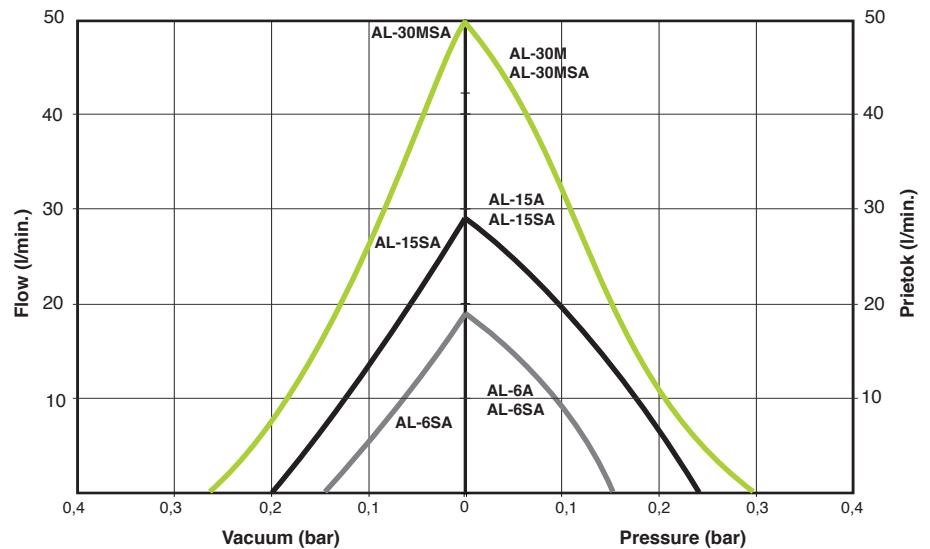

Model	AL-6A/ AL-6SA	AL-15A/ AL-15SA	AL-30M/ AL-30MSA
Rated current draw	0,1 A	0,2 A	0,25 A
Rated input power	13 W	26 W	35 W
Sound level	27 dB	29 dB	35 dB
Weight	2,4 kg	2,4 kg	3,7 kg
Rated pressure	100 mbar		200 mbar
Dimension L x W x H	150 mm x 130 mm x 111 mm		
Voltage, freq.	230V 50Hz		
IP coverage	IP54		

The single phase machines are designed with a +/- 10 % tolerance.. Information presented is based on test results from nominal units. Specifications are subject to change without notice.

ALITA_linear air pumps

Models pressure & vacuum

Models pressure & vacuum
AL-40SA, AL-60SA, AL80SA

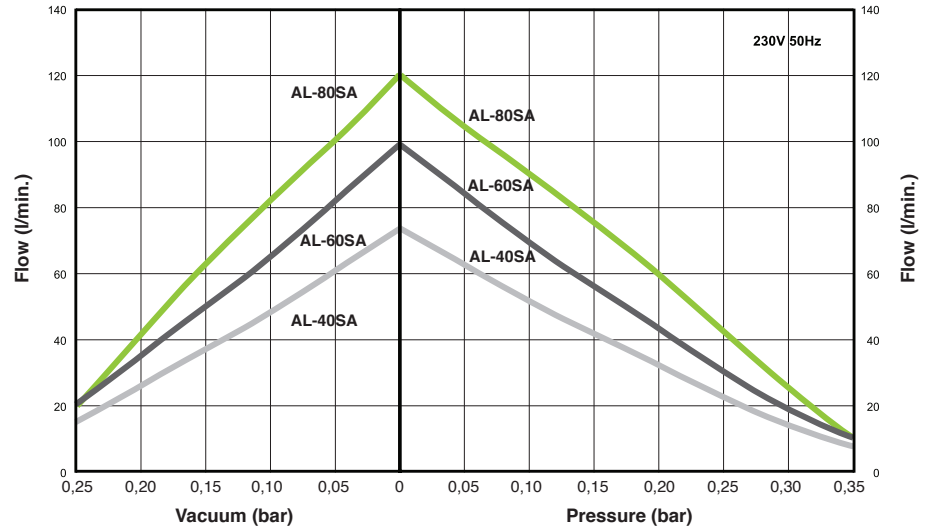

Model	AL-40SA	AL-60SA	AL-80SA
Rated input power	48 W	72 W	86 W
Sound level	36 dB	38 dB	39 dB
Weight	5.6 kg	6.5 kg	6.5 kg
Output ϕ	1/4" FPT		
Max. rated pressure	210 mbar		
Max. rated vacuum	150 mbar		
Rated input power (Max. rated pressure)	40 W	50 W	52 W
Voltage, freq	230V 50Hz		
IP coverage	IP54		
Dimension L x W x H	205 mm x 173 mm x 202 mm		

The single phase machines are designed with a +/- 10 % tolerance.. Information presented is based on test results from nominal units. Specifications are subject to change without notice.

1

ALITA_linear air pumps

1.3

OEM series

1

ALITA_linear air pumps

1.3

OEM series

ALITA_linear air pumps

OEM series of the air pump

page 1 z 2

In addition to a wide range of standard pump models that can be utilized off the shelf, we also offer OEM series of the linear air pumps which are customized for original equipment applications in the various areas of industry.

AL-6B
AL-15B
AL-20B

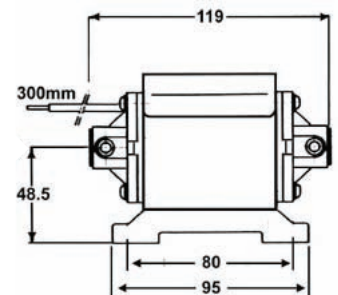
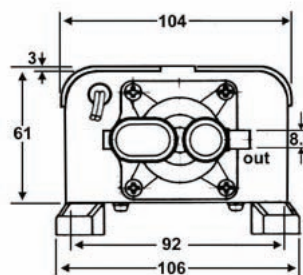

AL-6SB
AL-15SB
AL-20SB

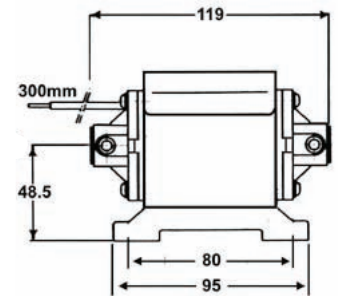
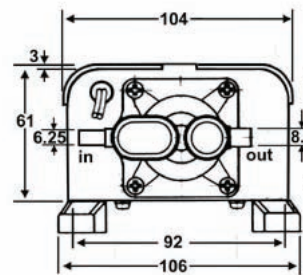

AL-30B
AL-40B
AL-50B

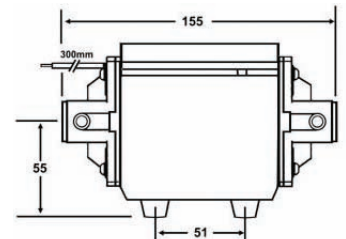
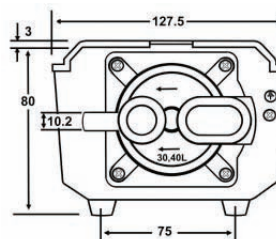

AL-30SB
AL-40SB
AL-50SB

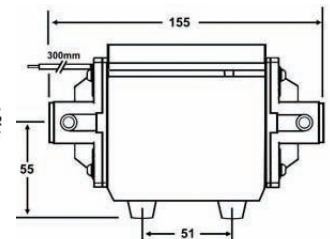
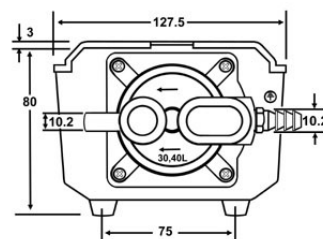

ALITA_linear air pumps

OEM series of the air pump

page 2 z 2

AL-60B

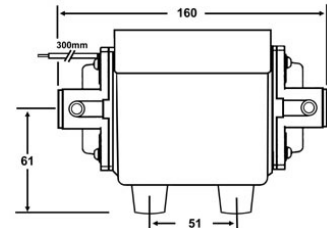
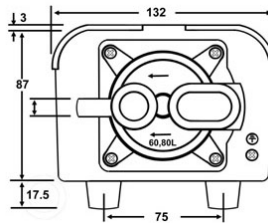

AL-60SB

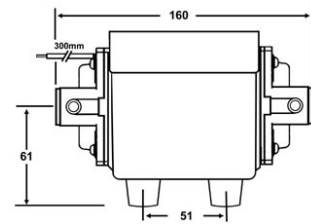
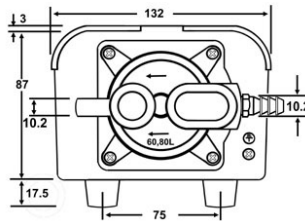

**AL-80B
AL-100B
AL-120B**



Pressure connection: 15mm (2x)
Dimension: 133 x 175 x 105 mm

**AL-80SB
AL-100SB
AL-120SB**



Pressure connection: 15mm (2x)
Vacuum connection: 10mm
Dimension: 133 x 175 x 105 mm

INECO

IN-ECO, spol. s r.o.
Radlinského 13
034 01 Ružomberok
Slovak Republic
T +421 44 4304662
F +421 44 4304663
E info@in-eco.eu
www.in-eco.eu

12.12.2018